

DataSheet

MT-E712

4-Channel, $\pm 25\text{mA}$, 16 Bit, 180kS/s, Analog Input Module

This document contains the specifications for MT-E712. Specifications are typical at 25°C unless otherwise noted.



Caution Using the MT-E712 in a manner not described in this document may impair the protection the MT-E712 provides.

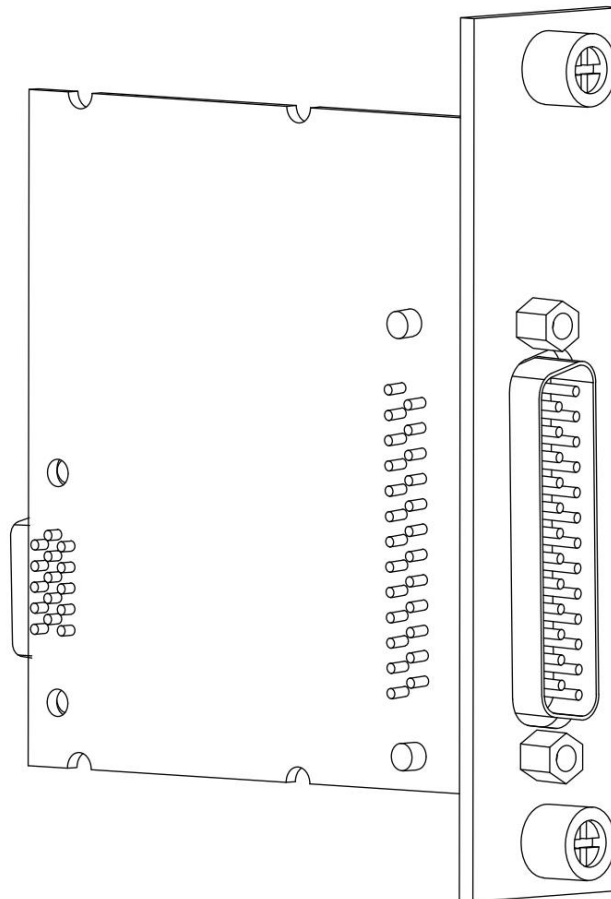

MT E Series Overview



MT provides more than 20 E Series modules for measurement, control, and communication applications. E Series modules can connect to any sensor or bus and allow for high-accuracy measurements that meet the demands of advanced data acquisition and control applications.

- Measurement-specific signal conditioning that connects to an array of sensors and signals
- Isolation options such as bank-to-bank, channel-to-channel, and channel-to-earth ground
- -40 °C to 70 °C temperature range to meet a variety of application and environmental needs
- Hot-swappable

The majority of E Series modules are supported in both RobustRIO and FlexDAQ platforms and you can move modules from one platform to the other with no modification.

RobustRIO



RobustRIO combines an open-embedded architecture with small size, extreme ruggedness, and E Series modules in a platform powered by the Redefinable I/O (RIO) architecture. Each system contains an FPGA for custom timing, triggering, and processing with a wide array of available modular I/O to meet any embedded application requirement.

FlexDAQ

FlexDAQ is a portable, rugged data acquisition platform that integrates connectivity, data acquisition, and signal conditioning into modular I/O for directly interfacing to any sensor or signal. Using FlexDAQ with LabVIEW, you can easily customize how you acquire, analyze, visualize, and manage your measurement data.



Software

LabVIEW Professional Development System for Windows

- Use advanced software tools for large project development
- Use advanced measurement analysis and digital signal processing
- Take advantage of open connectivity with DLLs, ActiveX, and .NET objects
- Build DLLs, executables, and MSI installers



LabVIEW FPGA Module

- Design FPGA applications for MT RIO hardware
- Program with the same graphical environment used for desktop and real-time applications
- Execute control algorithms with loop rates up to 300 MHz
- Implement custom timing and triggering logic, digital protocols, and DSP algorithms
- Incorporate existing HDL code and third-party IP including Xilinx IP generator functions

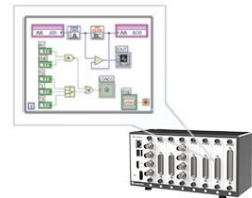

LabVIEW Real-Time Module

- Design deterministic real-time applications with LabVIEW graphical programming
- Take advantage of built-in PID control, signal processing, and analysis functions
- Automatically take advantage of multicore CPUs or set processor affinity manually
- Take advantage of real-time OS, development and debugging support, and board support

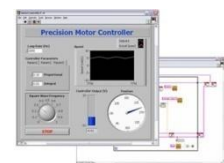

MT-E712 Connectivity

Pin definition of DSUB connector and Spring Terminal connector.

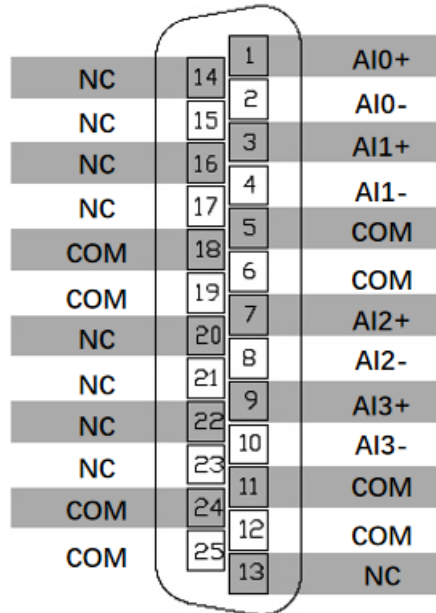

Connecting a grounded current source to the MT E712.

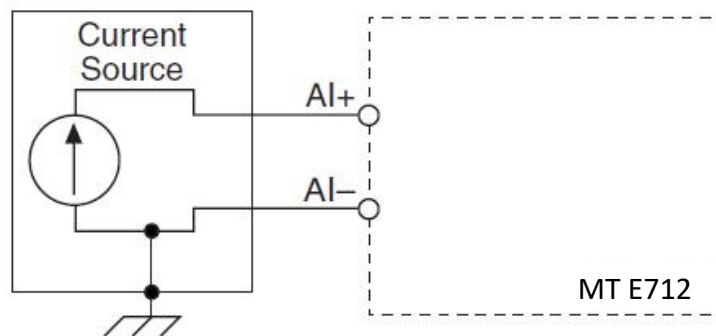

Connecting a floating current source to the MT E712.

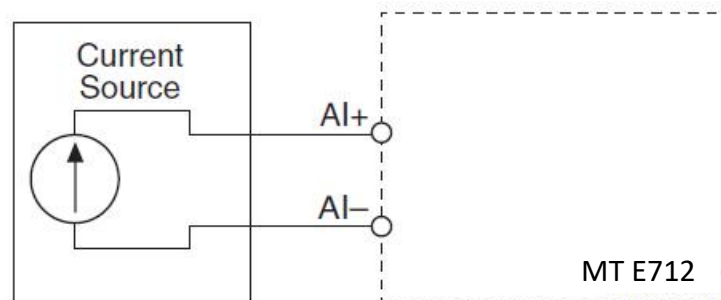

MT-E712 Circuitry

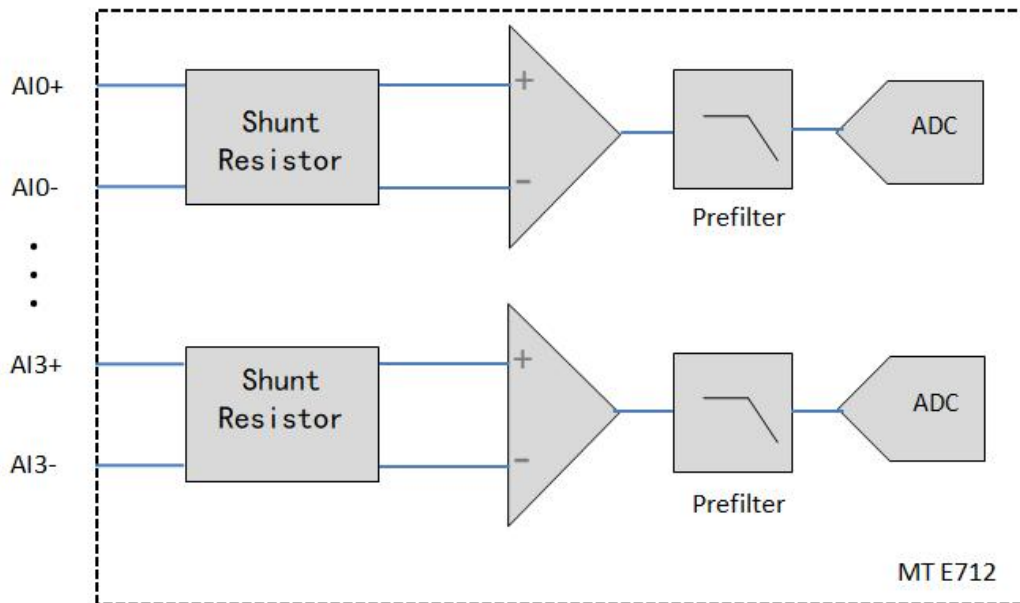

Input signals on each channel are buffered, conditioned, and then sampled by an ADC.

Each AI channel provides an independent signal path and ADC, enabling you to sample all channels simultaneously.

MT-E712 Specifications

The following specifications are typical for the range -40 °C to 70 °C unless otherwise noted.



Caution Do not operate the MT-E712 in a manner not specified in this document. Product misuse can result in a hazard. You can compromise the safety protection built into the product if the product is damaged in any way. If the product is damaged, return it to MangoTree for repair.



Caution The input terminals of this device are not protected from electromagnetic interference. As a result, this device may experience reduced measurement accuracy or other temporary performance degradation when connected cables are routed in an environment with radiated or conducted radio frequency electromagnetic interference. To limit radiated emissions and to ensure that this device functions within specifications in its operational electromagnetic environment, take precautions when designing, selecting, and installing measurement probes and cables.

Input Characteristics

Number of channels	4 analog input channels
ADC resolution	16 bits
Type of ADC	Successive approximation register (SAR)
Input current ranges	$\pm 25\text{mA}$
Overvoltage protection	$\pm 30\text{ V}$
Sample mode	Simultaneous
Sample rate	180 kS/s maximum per channel

Table 1. Accuracy

	Measurement Conditions	Percent of Reading (Gain Error)	Percent of Range (Offset Error)
Calibrated	Maximum (-40 °C to 70 °C)	$\pm 0.20\%$	$\pm 0.09\%$
	Typical (25 °C, $\pm 5\text{ °C}$)	$\pm 0.08\%$	$\pm 0.03\%$

Stability

Gain drift	$\pm 17\text{ ppm/°C}$
Offset drift	86nA/°C
CMRR	120 dB minimum
-3 dB bandwidth	$> 85\text{kHz}$
Input impedance(AI+ to AI-)	$12\text{ m}\Omega$
Input noise	
RMS	1LSBrms
Peak-toPeak	7LSB
Crosstalk(at 1 kHz)	-90 dB
Settling time (to 2 LSBs)	5.5us

Power Requirements

Power consumption from chassis	730 mW maximum
Thermal dissipation (at 70 °C)	1230 mW maximum

Safety Voltages

Connect only voltages that are within the following limits:

MT-E712 with DSUB Safety Voltages

Isolation

Channel-to-COM	None
Channel-to-earth ground	
Continuous	60 VDC, Measurement Category I
Withstand up to 2,000 m	1,000 Vrms, verified by a 5 s dielectric withstand test

Measurement Category I is for measurements performed on circuits not directly connected to the electrical distribution system referred to as MAINS voltage. MAINS is a hazardous live electrical supply system that powers equipment. This category is for measurements of voltages from specially protected secondary circuits. Such voltage measurements include signal levels, special equipment, limited-energy parts of equipment, circuits powered by regulated low-voltage sources, and electronics.

CE Compliance

This product meets the essential requirements of applicable European Directives, as follows:

- 2014/35/EU; Low-Voltage Directive (safety)
- 2014/30/EU; Electromagnetic Compatibility Directive (EMC)
- 2014/34/EU; Potentially Explosive Atmospheres (ATEX)

Shock and Vibration

To meet these specifications, you must panel mount the system.

Operating vibration

Random (IEC 60068-2-64)	5 g _{rms} , 10 Hz to 500 Hz
Sinusoidal (IEC 60068-2-6)	5 g, 10 Hz to 500 Hz
Operating shock (IEC 60068-2-27)	30 g, 11 ms half sine; 50 g, 3 ms half sine; 18 shocks at 6 orientations

Environmental

Refer to the manual for the chassis you are using for more information about meeting these specifications.

Operating temperature	-40 °C to 70 °C (IEC 60068-2-1, IEC 60068-2-2)
Storage temperature	-40 °C to 85 °C (IEC 60068-2-1, IEC 60068-2-2)
Ingress protection	IP40
Operating humidity (IEC 60068-2-78)	10% RH to 90% RH, noncondensing Storage
humidity (IEC 60068-2-78)	5% RH to 95% RH, noncondensing Pollution
Degree	2
Maximum altitude	
For MT-E712 with DSUB	2,000 m

Indoor use only.

Support

MT-RIO上手指南:

<http://server.mangotree.cn:9900/WebFile/Downloads/上手指南/MT-RIO/>



RIO上手指南

MT-RIO视频教程:

<http://server.mangotree.cn:9900/WebFile/Downloads/视频教程/MT-RIO/>



RIO视频教程

MT-Master上手指南:

<http://server.mangotree.cn:9900/WebFile/Downloads/上手指南/MT-Master/>



Master上手指南

MT-Master视频教程:

<http://server.mangotree.cn:9900/WebFile/Downloads/视频教程/MT-Master/>



Master视频教程

Dimensions:(mm)

