

DataSheet

MT-E741

4 AI, ± 5 V, 24 Bit, 102.4 kS/s/ch Simultaneous, AC/DC Coupling,
IEPE AC Coupling

This document contains the specifications for MT-E741. Specifications are typical at 25°C unless otherwise noted.



Caution Using the MT-E741 in a manner not described in this document may impair the protection the MT-E741 provides.

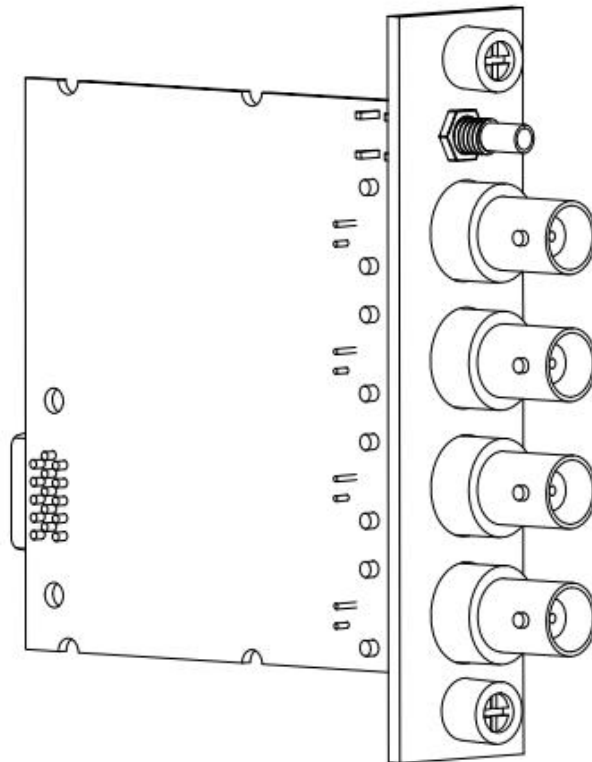

MT E Series Overview



MT provides more than 20 E Series modules for measurement, control, and communication applications. E Series modules can connect to any sensor or bus and allow for high-accuracy measurements that meet the demands of advanced data acquisition and control applications.

- Measurement-specific signal conditioning that connects to an array of sensors and signals
- Isolation options such as bank-to-bank, channel-to-channel, and channel-to-earth ground
- -40 °C to 70 °C temperature range to meet a variety of application and environmental needs
- Hot-swappable

The majority of E Series modules are supported in both RobustRIO and FlexDAQ platforms and you can move modules from one platform to the other with no modification.

RobustRIO



RobustRIO combines an open-embedded architecture with small size, extreme ruggedness, and E Series modules in a platform powered by the Redefinable I/O (RIO) architecture. Each system contains an FPGA for custom timing, triggering, and processing with a wide array of available modular I/O to meet any embedded application requirement.

FlexDAQ

FlexDAQ is a portable, rugged data acquisition platform that integrates connectivity, data acquisition, and signal conditioning into modular I/O for directly interfacing to any sensor or signal. Using FlexDAQ with LabVIEW, you can easily customize how you acquire, analyze, visualize, and manage your measurement data.



Software

LabVIEW Professional Development System for Windows

- Use advanced software tools for large project development
- Use advanced measurement analysis and digital signal processing
- Take advantage of open connectivity with DLLs, ActiveX, and .NET objects
- Build DLLs, executables, and MSI installers

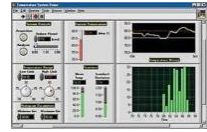

LabVIEW FPGA Module

- Design FPGA applications for MT RIO hardware
- Program with the same graphical environment used for desktop and real-time applications
- Execute control algorithms with loop rates up to 300 MHz
- Implement custom timing and triggering logic, digital protocols, and DSP algorithms
- Incorporate existing HDL code and third-party IP including Xilinx IP generator functions

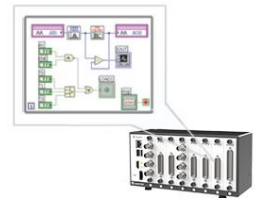

LabVIEW Real-Time Module

- Design deterministic real-time applications with LabVIEW graphical programming
- Take advantage of built-in PID control, signal processing, and analysis functions
- Automatically take advantage of multicore CPUs or set processor affinity manually
- Take advantage of real-time OS, development and debugging support, and board support

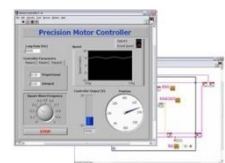

MT-E741 Circuitry

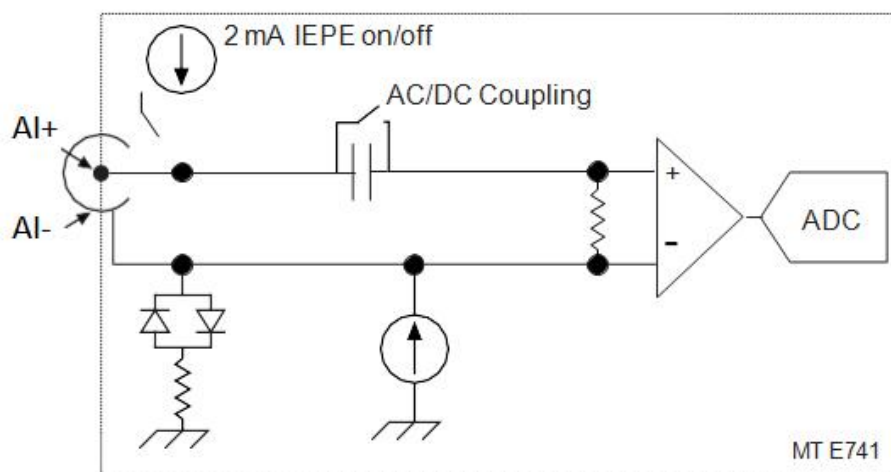

The input signal on each channel is buffered, conditioned, and then sampled by a 24-bit Delta-Sigma ADC.

AC/DC Coupling

You can configure each channels in hardware for AC or DC coupling. For channels set to AC coupling, you can turn the the IEPE excitation current on or off.

MT E741 AC/DC Configuration

Configuration	Dial Switch				
	S1	S2	S3	S4	S5
DC Coupling	OFF	OFF	OFF	OFF	ON
AC Coupling	OFF	ON	ON	OFF	OFF
AC Coupling with IEPE	ON	ON	ON	ON	OFF

Example: E741 with DC Coupling

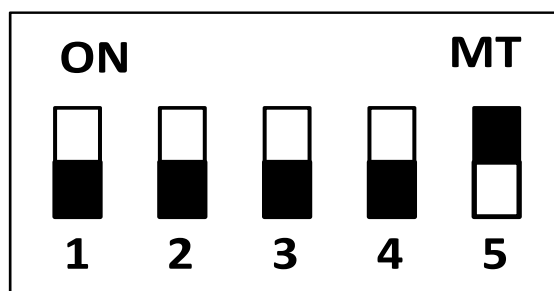

Clock Source

You can select clock source supply to the Delta- Sigma ADC on E741. And there are one SMB interface which can be used to export a clock or receive a clock.

MT E741 ADC Clock Configuration

Clock Source	Dial Switch	
	S1	S2
Internal clock	ON	OFF
External clock (from SMB)	OFF	ON
Internal clock, and export internal clock to SMB	ON	ON

Example: ADC clock from internal clock

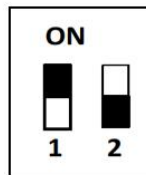

MT-E741 Specifications

The following specifications are typical for the range -40 °C to 70 °C unless otherwise noted.



Caution To ensure the specified EMC performance, operate this product only with shielded cables and accessories.



Caution Do not operate the MT-E741 in a manner not specified in this document. Product misuse can result in a hazard. You can compromise the safety protection built into the product if the product is damaged in any way. If the product is damaged, return it to MangoTree for repair.

Input Characteristics

Number of channels	4 analog input channels
ADC resolution	24 bits
Type of ADC	Delta-Sigma (with analog prefiltering)
Sampling mode	Simultaneous
Internal master timebase(f_M)	26.2144MHz
Data rate range(f_s)	
Minimum	3.303 kS/s
Maximum	102.4 kS/s
Data rates (f_s)	$(f_M \div 256)/n, n= 1,2,\dots,31$
Input coupling	AC/DC(hardware-selectable)
AC cutoff frequency	
-3dB	0.1Hz
Input range	$\pm 5V$
AC voltage full-scale range	
Minimum	$\pm 5V_{pk}$
Typical	$\pm 5.05V_{pk}$
Maximum	$\pm 5.15V_{pk}$
IEPE excitation current	
Minimum	2.0 mA
Typical	2.1 mA

IEPE compliance voltage	24V maximum
Overvoltage protection	±30V
Crosstalk(1 kHz)	-107dB
Passband	
Frequency	0.453 * f_s
Flatness($f_s = 102.4\text{kS/s}$)	39m dB (pk-to-pk maximum)
Stopband	
Frequency	0.547 * f_s
Rejection	105dB
Alias-free bandwidth	0.453 * f_s
Oversample rate	64 * f_s
CMRR	
Minimum	90dB
Typical	108dB
Differential input impedance	14k Ω
No missing codes	24Bits
Noise(shorted input)	8.5uVrms
Signal-to-noise ratio(SNR)	106dB
Total harmonic distortion(THD)	-108dB
Spurious-free dynamic range	109dB

Table 1. Accuracy

Measurement Conditions		Percent of Reading (Gain Error)	Percent of Range (Offset Error)
Calibrated	Maximum (-40 °C to 70 °C)	0.034%	±0.014%
	Typical (25 °C ±5 °C)	0.007%	±0.005%

AC Coupling, Input 1kHz sine wave, Power Spectrum and THD:

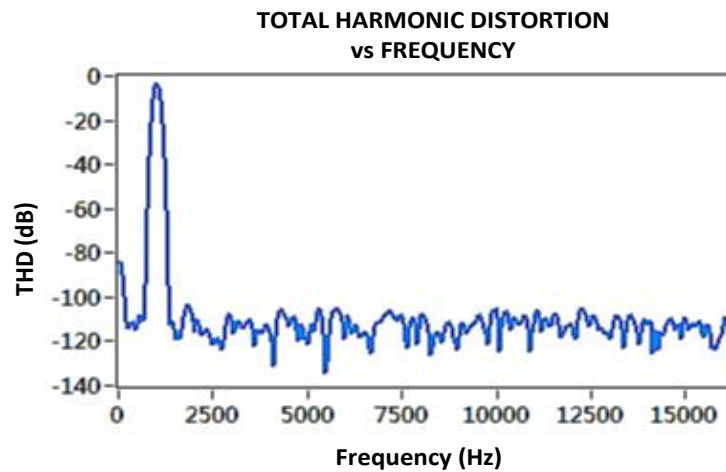
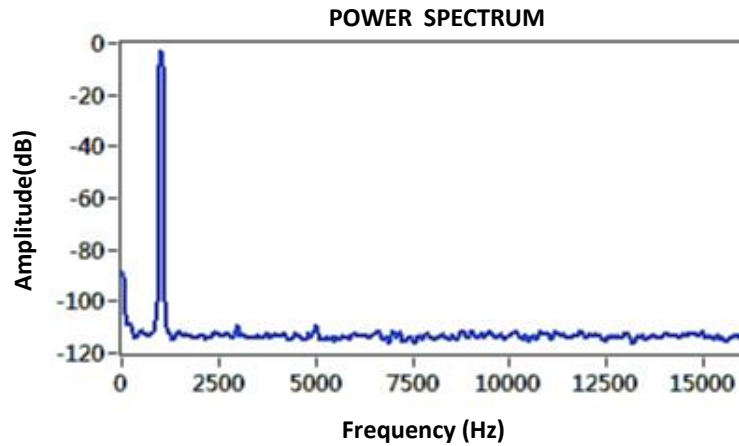

Power Requirements

Power consumption from chassis:	900mW maximum
---------------------------------	---------------

Thermal dissipation (at 70 °C)	930mW maximum
--------------------------------	---------------

Safety Voltages

Connect only voltages that are within the following limits:

Channel-to-earth ground	±30 V maximum, Measurement Category I
-------------------------	---------------------------------------

Isolation

Channel-to-channel	None
--------------------	------

Channel-to-earth ground	None
-------------------------	------

Measurement Category I is for measurements performed on circuits not directly connected to the electrical distribution system referred to as MAINS voltage. MAINS is a hazardous live electrical supply system that powers equipment. This category is for measurements of voltages from specially protected secondary circuits. Such voltage measurements include signal levels, special equipment, limited-energy parts of equipment, circuits powered by regulated low-voltage sources, and electronics.

CE Compliance

This product meets the essential requirements of applicable European Directives, as follows:

- 2014/35/EU; Low-Voltage Directive (safety)
- 2014/30/EU; Electromagnetic Compatibility Directive (EMC)
- 2014/34/EU; Potentially Explosive Atmospheres (ATEX)

Shock and Vibration

To meet these specifications, you must panel mount the system.

Operating vibration

Random (IEC 60068-2-64)	5 g _{rms} , 10 Hz to 500 Hz
Sinusoidal (IEC 60068-2-6)	5 g, 10 Hz to 500 Hz
Operating shock (IEC 60068-2-27)	30 g, 11 ms half sine; 50 g, 3 ms half sine; 18 shocks at 6 orientations

Environmental

Refer to the manual for the chassis you are using for more information about meeting these specifications.

Operating temperature	-40 °C to 70 °C (IEC 60068-2-1, IEC 60068-2-2)
Storage temperature	-40 °C to 85 °C (IEC 60068-2-1, IEC 60068-2-2)
Ingress protection	IP40

Operating humidity (IEC 60068-2-78)	10% RH to 90% RH, noncondensing Storage
humidity (IEC 60068-2-78)	5% RH to 95% RH, noncondensing Pollution
Degree	2
Maximum altitude	500m

Indoor use only.

Support

MT-RIO上手指南:

<http://server.mangotree.cn:9000/WebFile/Downloads/上手指南/MT-RIO/>



RIO上手指南

MT-RIO视频教程:

<http://server.mangotree.cn:9000/WebFile/Downloads/视频教程/MT-RIO/>



RIO视频教程

MT-Master上手指南:

<http://server.mangotree.cn:9000/WebFile/Downloads/上手指南/MT-Master/>



Master上手指南

MT-Master视频教程:

<http://server.mangotree.cn:9000/WebFile/Downloads/视频教程/MT-Master/>



Master视频教程

Dimensions:(mm)

